

FORIGO

SINCE 1972

F110TW

ERPICE INTERFILARE
INTER-ROW HARROW
GRADA ROTATIVA ENTRE HILERAS



HP 60 - 120
KW 45 - 89



cm 25
inch 10





HP 60 - 120
KW 45 - 89



cm 25
inch 10



IT

- Attacco a tre punti universale di cat. 2^a
- Riduttore a una velocità per PTO 540 g/min
- Protezione rotor in origine
- Albero portadente monolitico con esagoni incassati per le viti
- Dente ZEUS bidirezionale con profilo a basso assorbimento di potenza
- Lama livellatrice posteriore PARABLOC regolabile con manovelle montata sul rullo
- Fiancate laterali mobili montate su molle con prolunghe
- Regolazione profondità di lavoro meccanica con registri laterali
- Barra anteriore antinfortunistica
- Interfila regolabile con manovella
- Cardano con limitatore a bullone SB attacco trattore 1"3/8 Z=6

EN

- Universal 3-point linkage Cat. 2
- Single speed gearbox 540 rpm PTO
- Stone guards mounted on origin
- Monobloc tine-holder shaft hot-forged with hexagonal sockets for screws
- Special Tine system bi-directional "ZEUS" Ideal for a low power absorption
- Rear levelling clod bar PARABLOC adjustable by crank handles, mounted on the roller
- Adjustable side plates on springs
- Working depth adjustable by lateral pins on roller brackets
- Safety front bar
- Inter-row adjustable by crank handle
- Cardan shaft with shear bolt torque limiter SB type (1"3/8 Z=6 tractor side yoke)



ES

- Enganche de tres puntos universal de categoría 2
- Reductor de 1 velocidad para TDF 540 g/min
- Protección rotores, en origen
- Eje portadiente de una sola pieza con hexágonos encajado para los tornillos
- Diente ZEUS bidireccional con perfil de baja absorción de potencia
- Barra niveladora trasera PARABLOC regulable por manivelas, montada en el rodillo
- Laterales móviles sobre muelles
- Regulación mecánica de la profundidad de trabajo mediante posición de pernos manualmente
- Barra delantera prevención accidentes
- Entre filas ajustable con manivela
- Cardan de fusible SB - horquilla lado tractor 1"3/8 Z=6

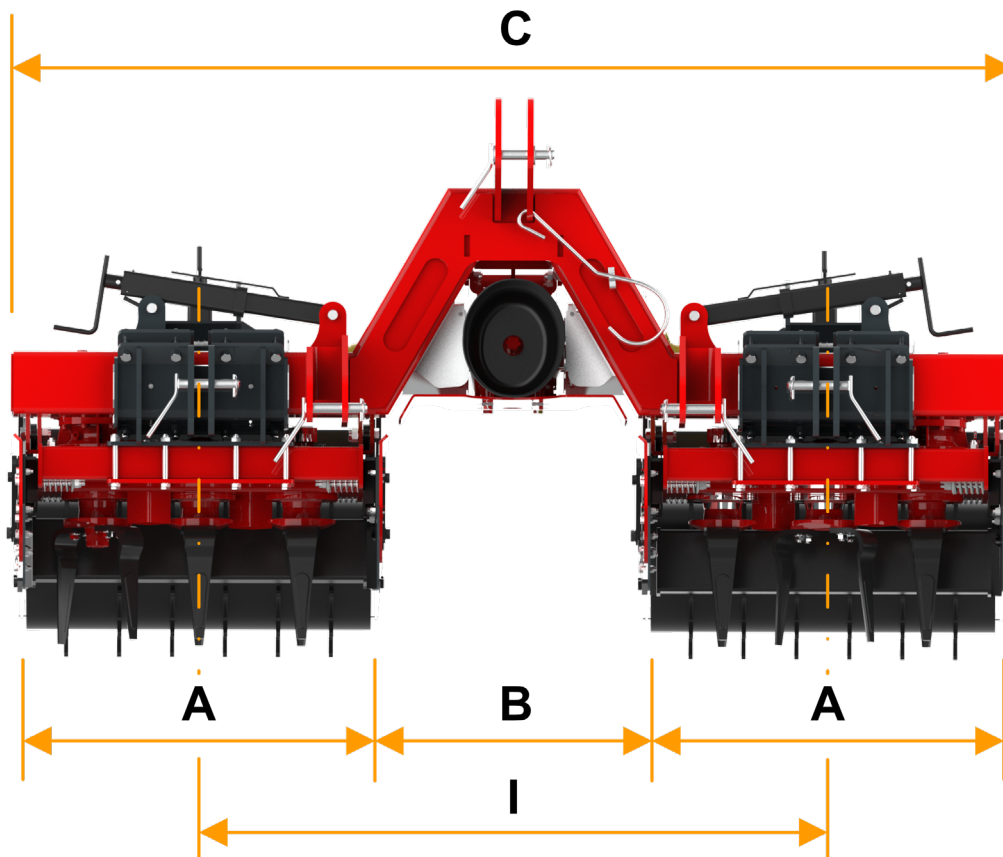

> DIMENSIONI / DIMENSIONS / DIMENSIONES



Mod.	A		B		C		I				
	cm	inch	cm	inch	cm	inch	cm	inch		n°	kg
F110 TW 4+4	61	24	72-117	28-46	200-245	79-96	135-180	53-71	4+4	890	1962
F110 TW 6+6	86	34	64-94	25-37	240-270	94-106	150-180	59-71	6+6	960	2116
F110TW 8+8	110	43	40-70	16-28	265-295	104-116	150-180	59-71	8+8	1020	2249
F110 TW 10+10	135	53	175-235	69-93	450-510	177-201	310-370	122-146	10+10	1450	3197



ACCESSORI / ACCESSORIES / ACCESORIOS

Regolazione a manovella interfila (di serie)
Working depth adjustable by lateral
pins on roller brackets
Regulación por manivella de la
distancia entre hileras

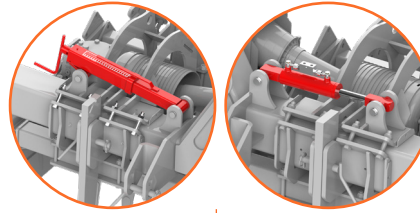

Regolazione idraulica inter-
fila (optional)
Hydraulic inter-row
adjustment
Regulación hidráulica
de la distancia entre
hileras



Ancora
in acciaio temprato
Still in hardened steel
Reja en acero templado

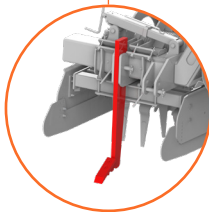

Bandella di conten-
tamento terra con
molle
Ground retaining
strip with springs
Chapa lateral
retencion
tierra con muelles

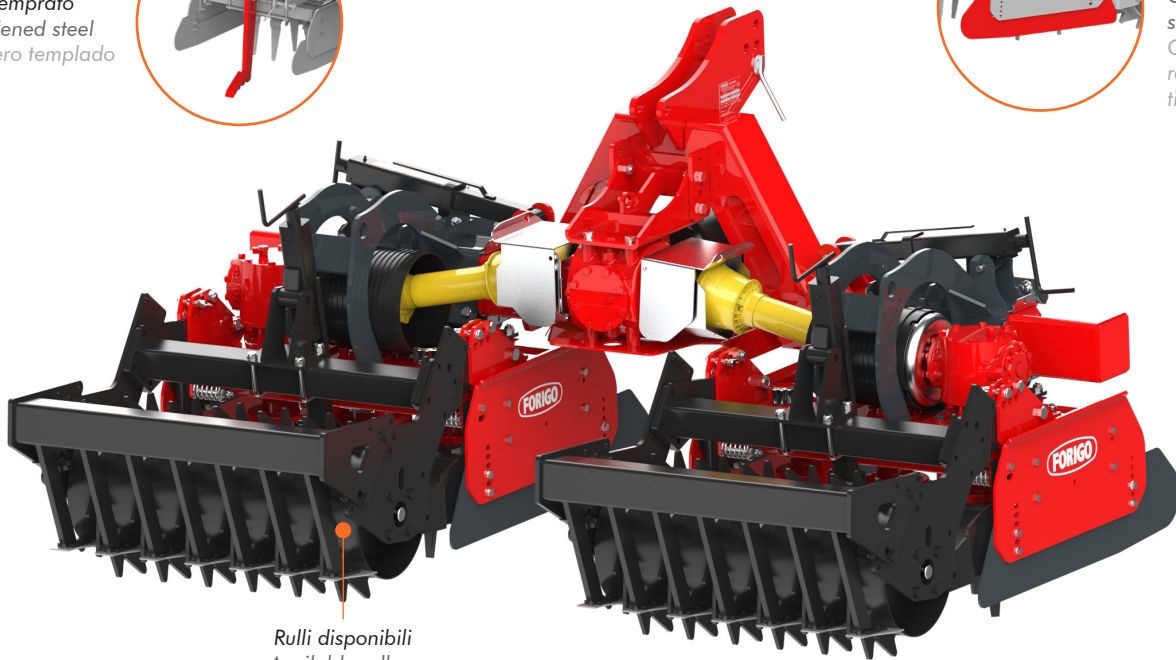
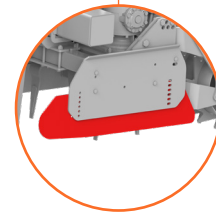

Rulli disponibili
Available rollers
Rodillos disponibles



Rullo packer
Paker roller
Rodillo packer



Rullo gabbia
Cage roller
Rodillo jaula



Rullo Spuntoni
Spikes roller
Rodillo de puas